

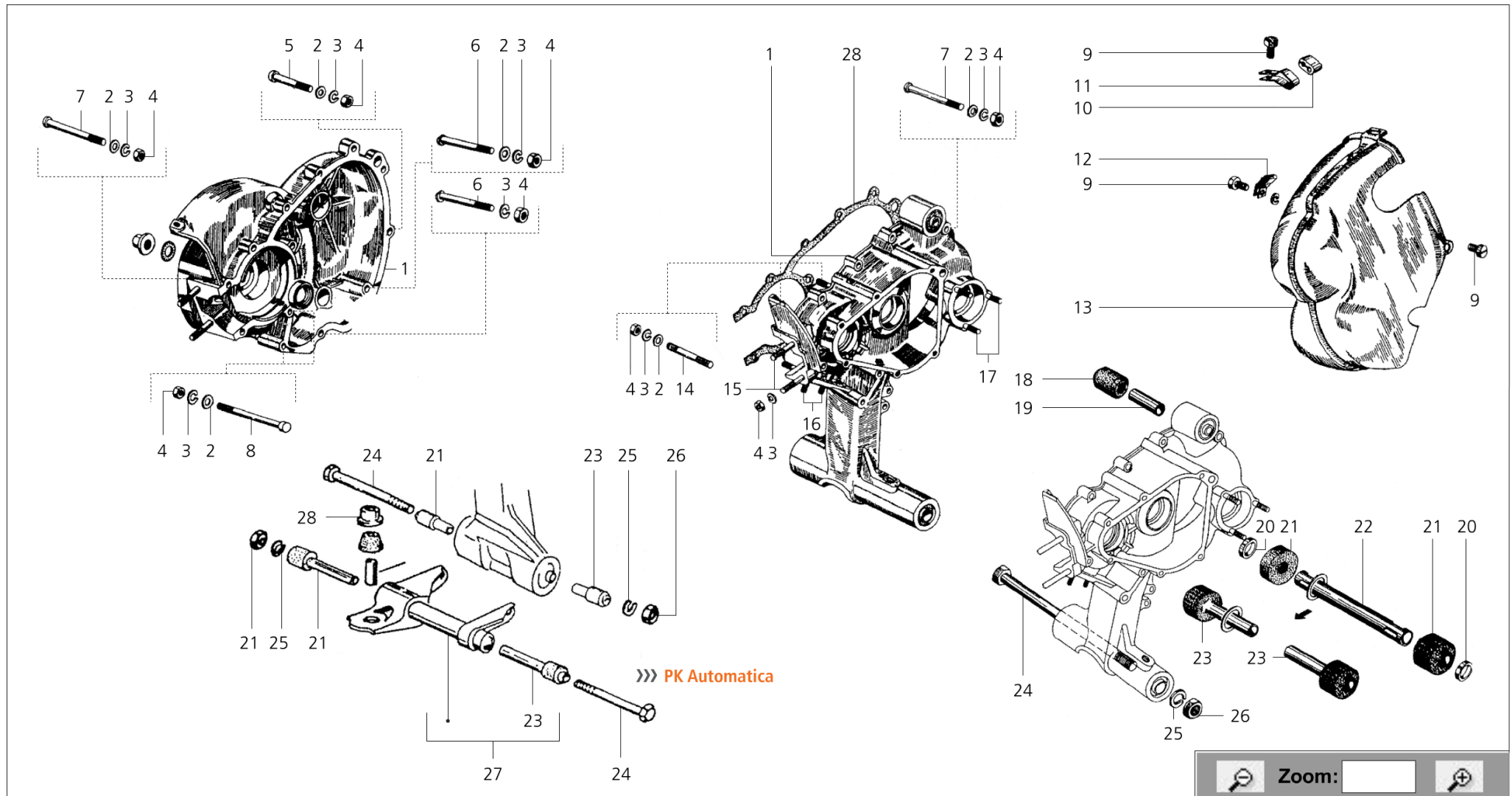





Vespa Smallframe/Alle/Tafel sma_T02: Motorgehäuse & Zylinderhaube



Nr	Artikelnummer	Name	Hersteller	Preis
5	84200000	Motorschraube V50/PK V50/PV/ET3/PK/S/XL/XL2 (5) M7x42mm	 PIAGGIO	1,70 €
8	84190000	Motorschraube V50/PX/PK/Cosa V50/PV/ET3/PK/S/XL/XL2 (2) T5/PX Lusso/LML/Cosa (1) M7x80mm	 PIAGGIO	2,50 €
11	97570000	Befestigungsklammer Kabel- führung Zylinderhaube oben V50 N/L/R/S/Special/SS/PV/ET3/PK50 -125/S/Lusso/SS/Elstart/XL/2	 PIAGGIO	1,80 €
12	97580000	Befestigungsklammer Kabel- führung Zylinderhaube seitlich V50/N/L/R/S/Special/SS/PV/ET3/ PK50-125/S/Lusso/SS/El/XL/XL2	 PIAGGIO	1,80 €
13	15073900	Zylinderhaube V125/PV/ET3/ PK125/ETS/N/S/XL/XL2	 D.R.T. DENIS RACING TEAM	10,90 €
13	13926100	Zylinderhaube V50/N 92877->/L/ R/S/Spezial/SS/PK50/S/Lusso/SS XL/2/FL/N/Rush	 PIAGGIO	10,90 €
15	48000000	Zylinderstehbolzen kurz V50/ N/L/R/Special/S/SR/SS/90/R/SS/ 100/PK50S/XL/XL2/PK80S (4) M7x35mm	 PIAGGIO	1,90 €
16	58400000	Stehbolzen M6x30 Ansaugstutzen V50/90/100/PV/PK50-125/S/SS/XL 2/HP/N/R/ETS, Auslass Peugeot Scooters/V50/90/100/PV/PK	 PIAGGIO	1,30 €
18	40316000	Silentgummi Stoßdämpferauf- nahme Motorgehäuse PX/T5/Cosa, V50/PV/ET3/PK 30x35x15mm	 PIAGGIO	2,40 €

SIP Scootershop GmbH
Graf Zeppelin Str. 9
D-86899 Landsberg

 **0 8191 96999 60**
 **0049 8191 96999 69**
 **0049 8191 96999 20**
 **0049 8191 96999 55**
Fax. 0049 8191 96999 70

Einkaufen im SIP Webstore:
www.sip-scootershop.com





CASH
Point
SIP-SCOOTERSHOP

Das neue SIP Scootershop Prämienprogramm!
www.sip-scootershop.com/cashpoint

SIP Scooter-Community
Pictures Blogs Forums Movies CashPoints Webstore

WWW.SCOOTCOMMUNITY.COM
community.sip-scootershop.com



Nr	Artikelnummer	Name	Hersteller	Preis
21	11204000	Silentgummi Schwinge Motor V50/N/L/R/Special/Elestart/S /SR/SS rechts/links, 39-21-10 PK50/S/XL/XL2/FL links		6,40 €
24	87501000	Motorbolzen Schwinge V50/PV/ET3 PK/S/XL/XL2/FL PK Automatica		5,50 €
25	16411000	Sprengring Motorbolzen V50/PV/ ET3/PK/XL/Automatica, M10 Auspuff PX/T5,Cosa/V50/PV/ET3 Stoßdämpfer vorne oben PK/PX		0,50 €
26	15252000	Mutter Motorbolzen V50/PV/ET3/ PK/XL/Automatica, M10		2,10 €

SIP Scootershop GmbH

Graf Zeppelin Str. 9
D-86899 Landsberg

 **0 8191 96999 60**
 **0049 8191 96999 69**
 **0049 8191 96999 20**
 **0049 8191 96999 55**
Fax. 0049 8191 96999 70

Einkaufen im SIP Webstore:

www.sip-scootershop.com



Das neue SIP Scootershop Prämienprogramm!
www.sip-scootershop.com/cashpoint

